

(一社)日本配電制御システム工業会 非常用配電盤等機器認定委員会登録品
耐火形扉用把手

特徴 Feature

- 耐火・耐熱・耐塩・耐酸(A-1147)
- 左右兼用型
- Fire-resistant, heat-resistant, saltwater-resistant and acid-resistant. (A-1147)
- For both left-hand and right-hand use.

仕様	● 材質: 下記表による ● 表面仕上: 下記表による ● 付属品: 大ナット・ビスセット
用途	● 屋外配分電盤・制御盤
納期	● 標準在庫品
備考	● ステンレス製防水キャップ(A-120-2用キャップ)が併用できます。(A-1147-2のみ) ● No.0061-H・No.0062-Hは別売です。詳細は269ページをご参照ください。 ● チタニウム製も製作します。 ● 止め金取付け用M8ナットの締付けトルクは6.2N・m以下で行ってください。(A-147) ● 本製品の止め金取付け用ねじは、緩み防止のため「緩み防止剤」の塗布をお奨めします。

Specifications	● Material: See the table below ● Finish: See the table below ● Accessories: Large nut and screws
Specific-use	● Outdoor power/distribution and control boards
Remarks	● Stainless steel waterproof cap (for A-120-2) can be used together. (A-1147-2 only) ● No.0061-H・No.0062-H are optional. See page 269. ● Set the torque of the M8 nut for stopper plate within 6.2N・m. (A-147) ● It is recommended that thread-locking fluid be used to prevent loosening of the mounting screws for the catch.

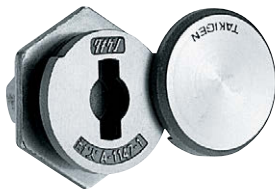

A-1147-1



No.0062-H



No.0061-H



A-1147-2



A-120-2キャップ cap

[A-1147-1・A-147-1]

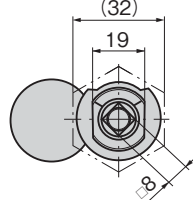
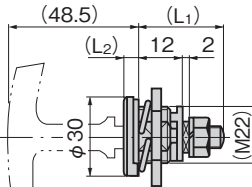
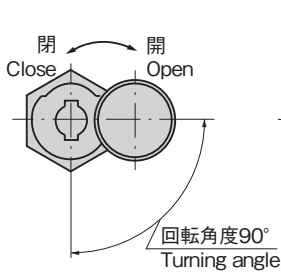

[A-120-2キャップ] cap

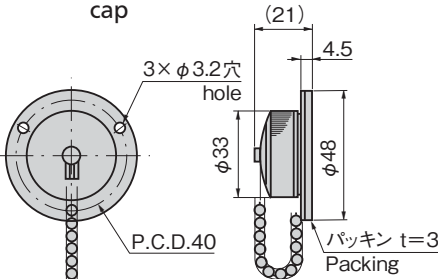

[A-1147-2]

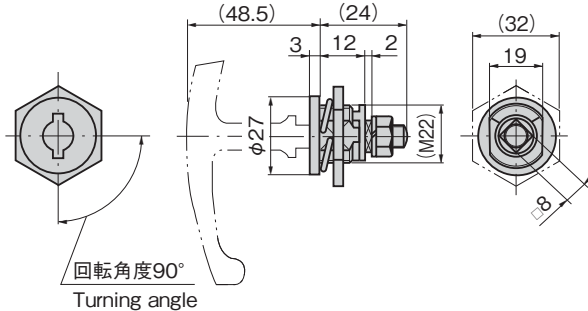

パネル穴明け寸法
Panel drilling dimensions

[A-120-2用キャップ] cap

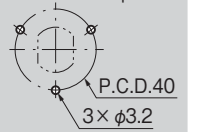

[A-1147]

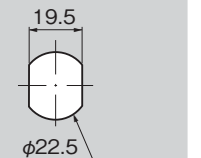

開扉 Open door

▲ 振動や止め金の自重落下防止のため開扉の際止め金が上方向に回転する設定をお奨めします。

▲ Recommend to use the setting to prevent vibration or stopper plate from naturally falling, i.e. the stopper plate turns upward when unlocking the door.

止め金 Stopper plate

止め金は640~644ページの□8穴の中からお選びください。
Select the stopper plate with □8-hole on page 640 to 644.

商品番号 Product No.	RoHS 10	備考 Remarks	材質 Material	表面仕上 Finish	(L1)	(L2)	最大適用板厚 Max.applicable panel thickness	製品質量(g) Mass	コード Code
A-1147-1	●	蓋あり With cover	ステンレス鋼铸件(SUS316) Cast stainless steel (SUS316)	本体/ビーズショット処理 Main body/Beading process	24	6.5	1.8	75	03665
A-1147-2	●	蓋なし Without cover		電解研磨 Electrolytic polishing	24		1.8	75	00743
A-147-1		蓋あり With cover	亜鉛合金(ZDC) Zinc alloy (ZDC)	クロムめっき(MZCr) Chrome plating(MZCr)	26	6	1.8	65	00329
A-120-2 キャップ cap		A-1147-2用キャップ cap	冷間圧延ステンレス鋼板 Cold rolled stainless steel plate	光沢バレル研磨 Gloss barrel polishing					00260

●: RoHS10指令対応品 ▲: RoHS10指令に対応可能です。